

FIRST ANGLE PROJECTION - DO NOT SCALE - IF IN DOUBT ASK - ALL MEASUREMENTS IN MM - REMOVE ALL SHARP EDGES - TOLERANCES UNLESS STATED: LINEAR±0.5 TOL/ ANGULAR±0.5 DEG.

DESIGNED TO SUIT
41x41 STRUT SUPPLIED
BY OTHERS

DRAINAGE CHANNELS TO
UNDERSIDE OF GRP FOOT

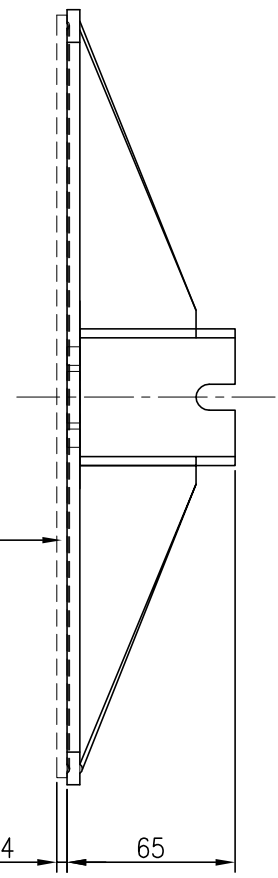
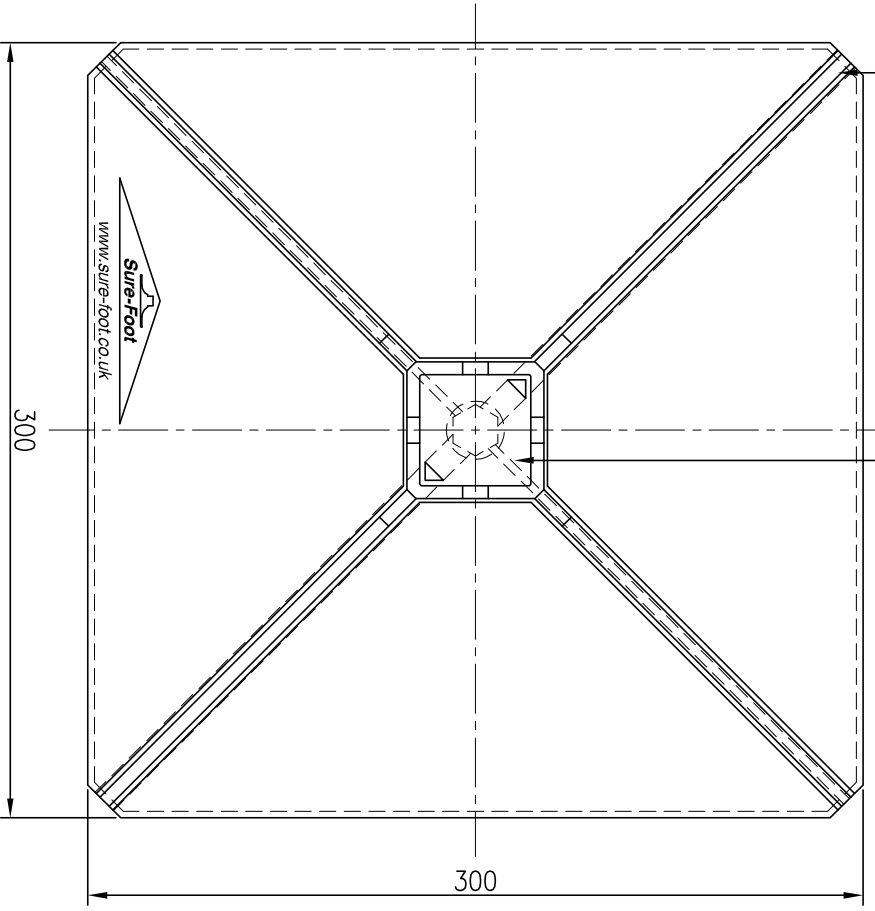

4mm BONDED RUBBER MAT
TO UNDERSIDE OF GRP FOOT

GALVANISED MILD STEEL
L-ANGLE BRACKETS

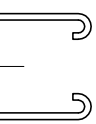
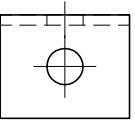
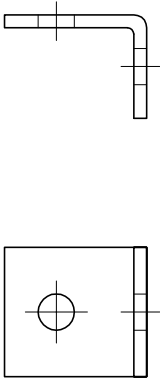

41x41mm STRUTS
(500mm LENGTH)

REMARKS: © COPYRIGHT ROOF-PRO LTD

THIS DRAWING IS INDICATIVE OF THE SURE-FOOT RANGE OF STANDARD COMPONENTS ONLY. IT IS THE CLIENT'S RESPONSIBILITY TO ENSURE THE USE OF THESE COMPONENTS IS SUITABLE FOR THESE SPECIFIC REQUIREMENTS.



Polwell Lane, off Station Road
Burton Latimer, NN15 5PS, UK
Tel: +44 (0)1536 383 865
Email: surefoot@roof-pro.co.uk
Website: www.roof-pro.co.uk

PRODUCT:
300 H FRAME



SCALE @ A4:	NTS
DRAWN BY:	CAD
DATE:	01/04/14
CHECKED BY:	CAD
DATE:	01/04/14
DRAWING No.	SF300-H 1
REV:	-

THIS DRAWING IS INDICATIVE OF THE SURE-FOOT RANGE OF STANDARD COMPONENTS ONLY. IT IS THE CLIENT'S RESPONSIBILITY TO ENSURE THE USE OF THESE COMPONENTS IS SUITABLE FOR THEIR SPECIFIC REQUIREMENTS.

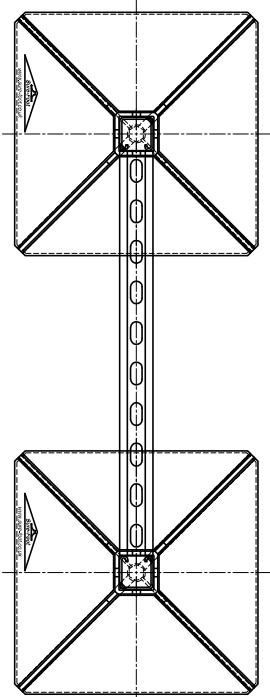
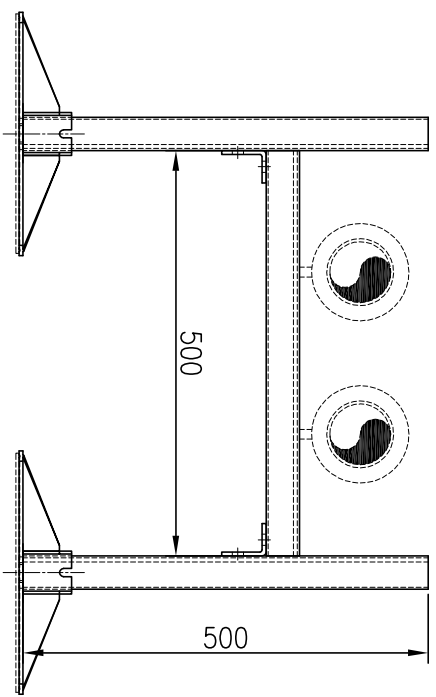

TYPICAL PIPEWORK SUPPORT EXAMPLE
ORDER REQUIREMENTS SF300-H

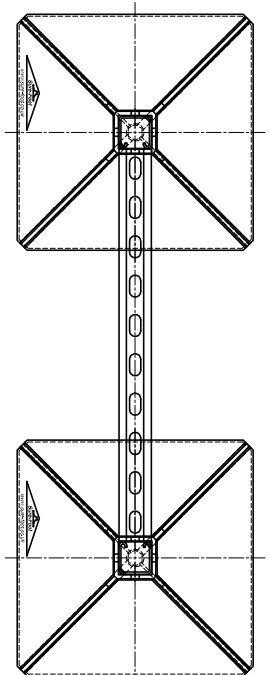
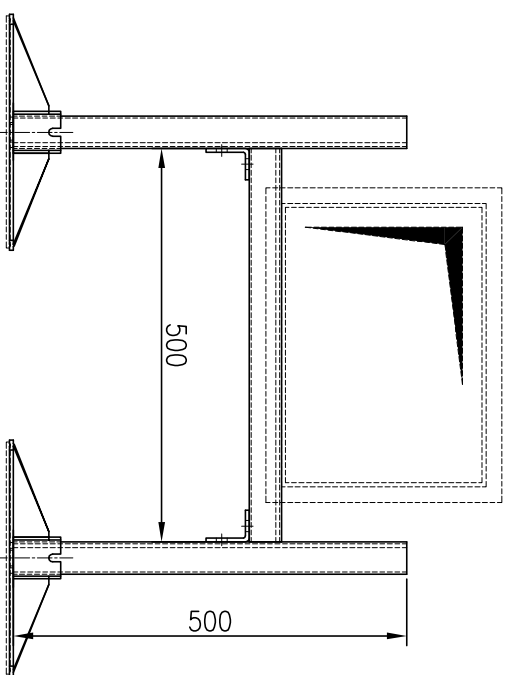

TYPICAL DUCTWORK SUPPORT EXAMPLE
ORDER REQUIREMENTS SF300-H



Polwell Lane, off Station Road
Burton Latimer, NN15 5PS, UK

Tel: +44 (0)1536 383 865
Email: surefoot@roof-pro.co.uk
Website: www.roof-pro.co.uk

PRODUCT:
300 H FRAME
TYPICAL APPLICATIONS



SCALE @ A4:	NTS
DRAWN BY:	CAD
DATE:	01/04/14
CHECKED BY:	CAD
DATE:	01/04/14
DRAWING No.	SF300-H 2
REV:	-